

Article number: 2310304021ESD

Description: E+G Antistatic base for levelling elements  
LV.A-70-14-M10x43-ESD-C

## Measures

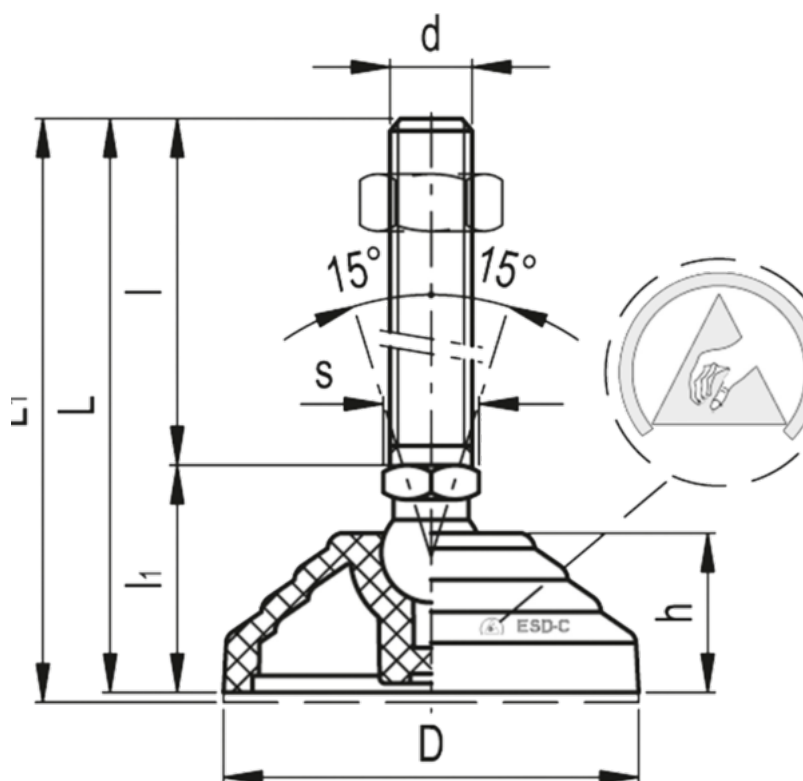

Articulation = 14  
D = 70  
d = M10  
h = 19  
l = -  
l1 = -  
L = 71  
Max load = 14000

s = 14  
Weight in (g) = 69